

**Manual de Instalação da Fonte
Cougar VTE500 com Chicote
Exclusivo pra DPMB**

Passo a Passo

+

**Diagrama de
Conexões**



Manual PDF

Manual Passo a Passo



IMPORTANTE: Não utilizar os cabos **Bx129** e **Bx130**

1. Abrir o gabinete e retirar o cartão DTCV e a fonte antiga:

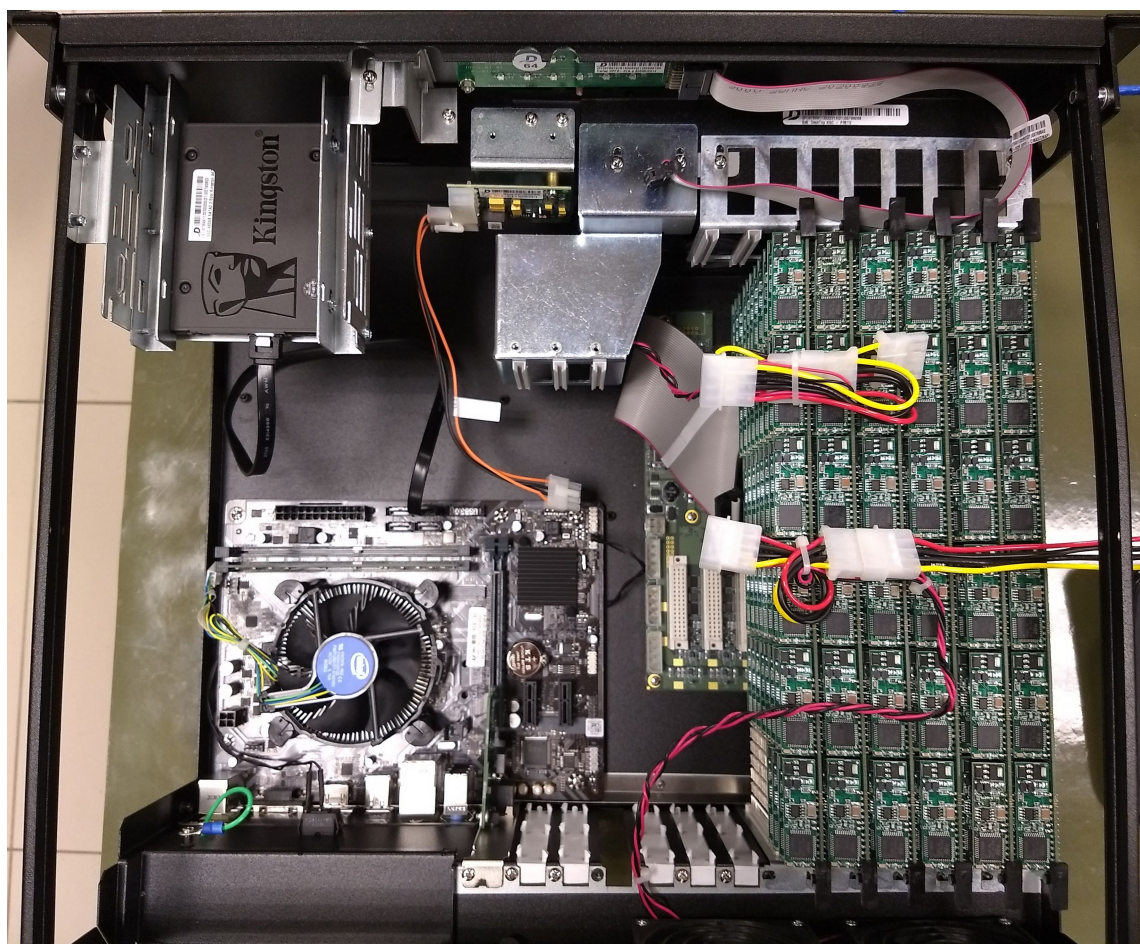

2. Fixar a fonte Cougar VTE500 com chicote exclusivo para DPMB (11000220):

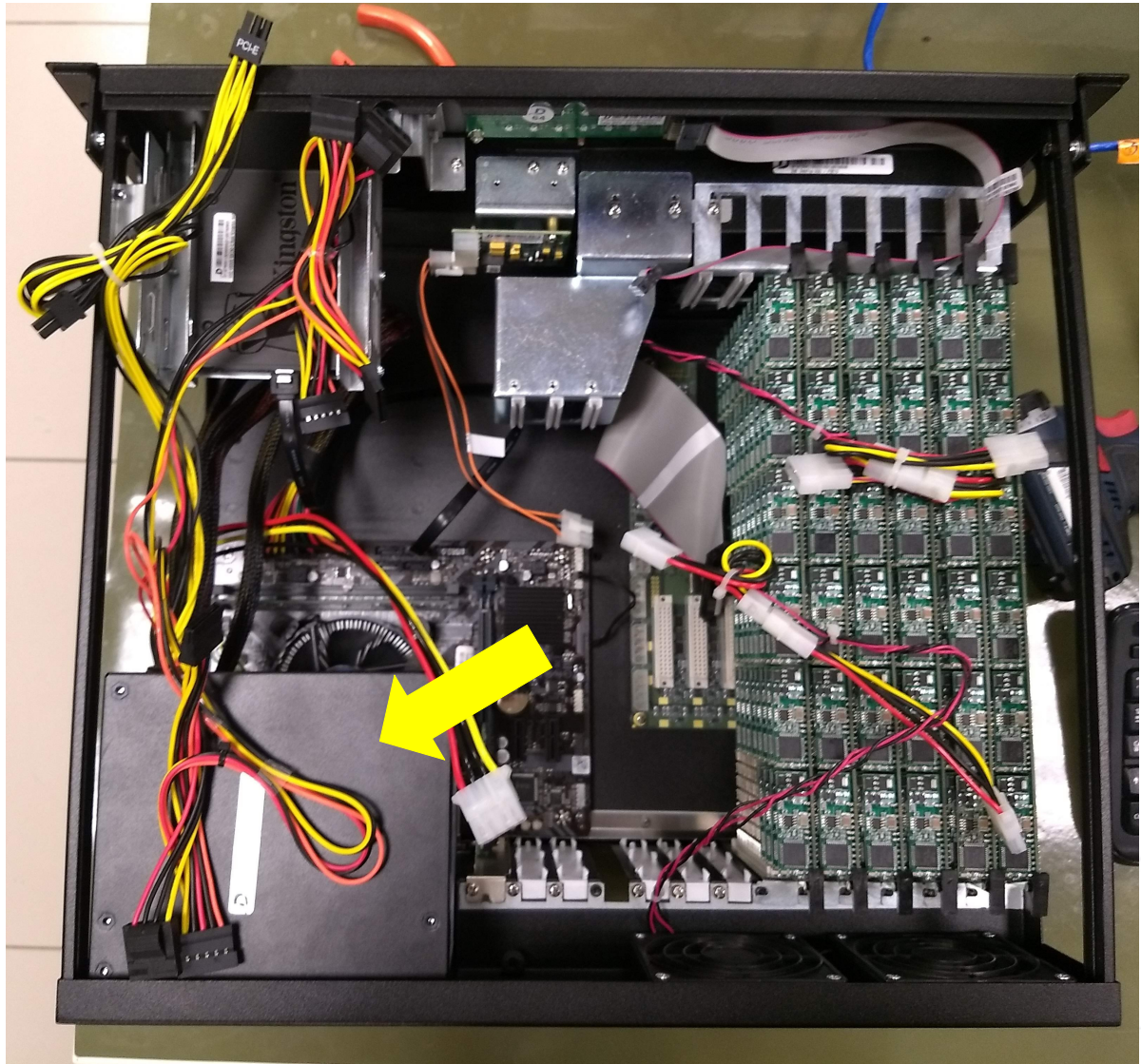

3. Conectar os dois cabos de alimentação da placa mãe (Main connector e CPU 4+4):

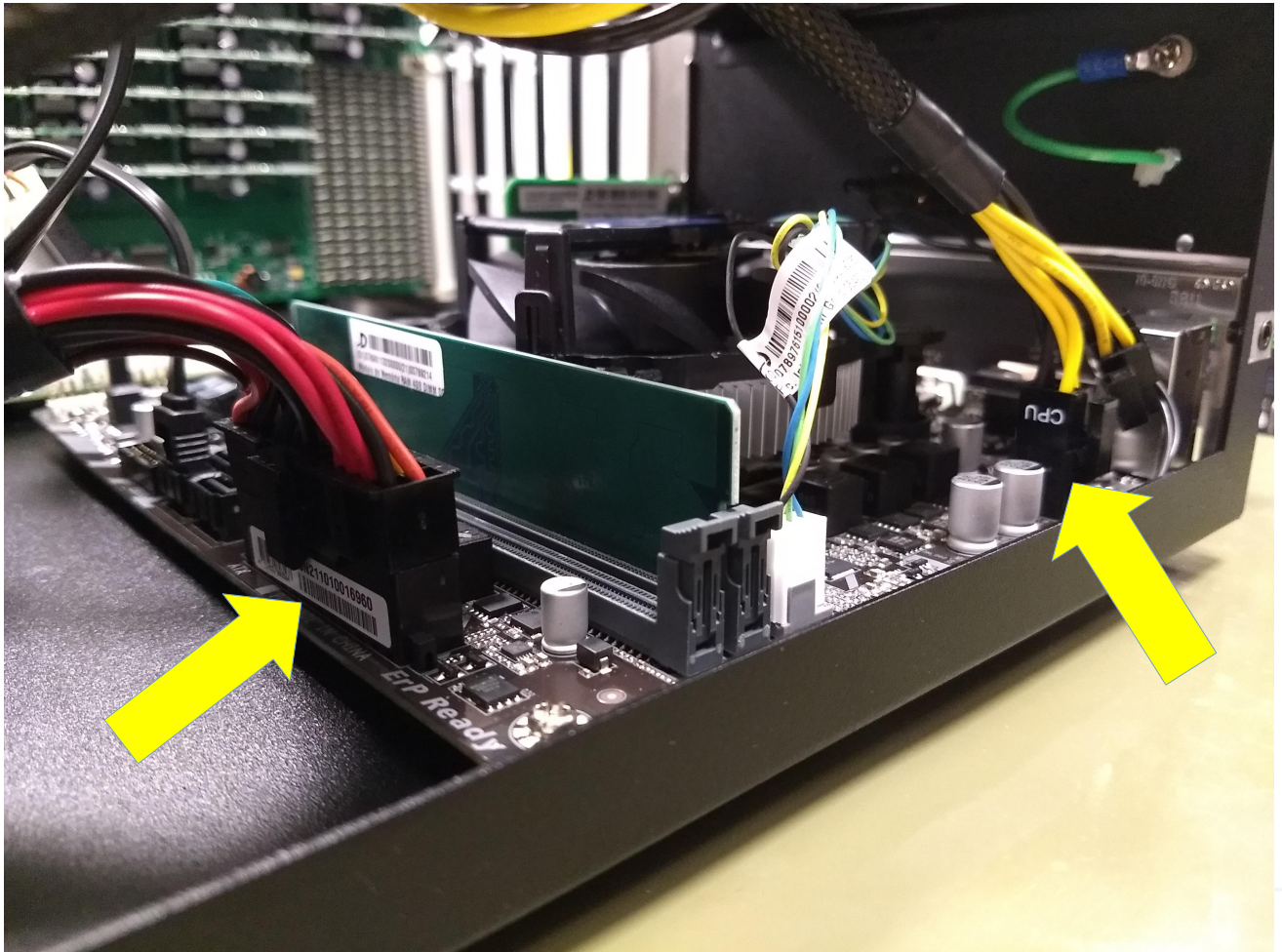

4. Conectar o cabo com etiqueta **DPMB** no conector do cartão DPMB que está mais próximo ao canto da placa:

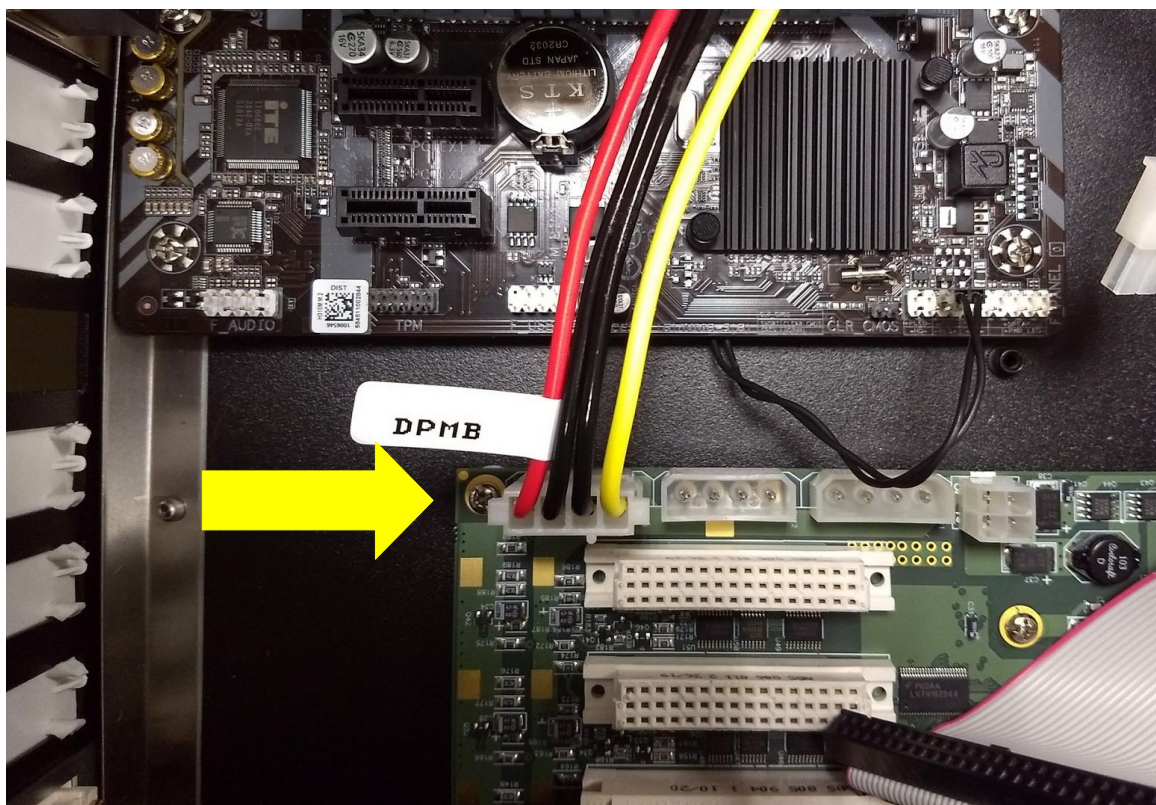

5. Conectar o cabo com etiqueta **DEVM** no cartão DEVM:



6. Conectar o(s) plug(s) SATA do cabo com etiqueta **SSD/HD VENT.** no(s) SSD(s)/HD(s):

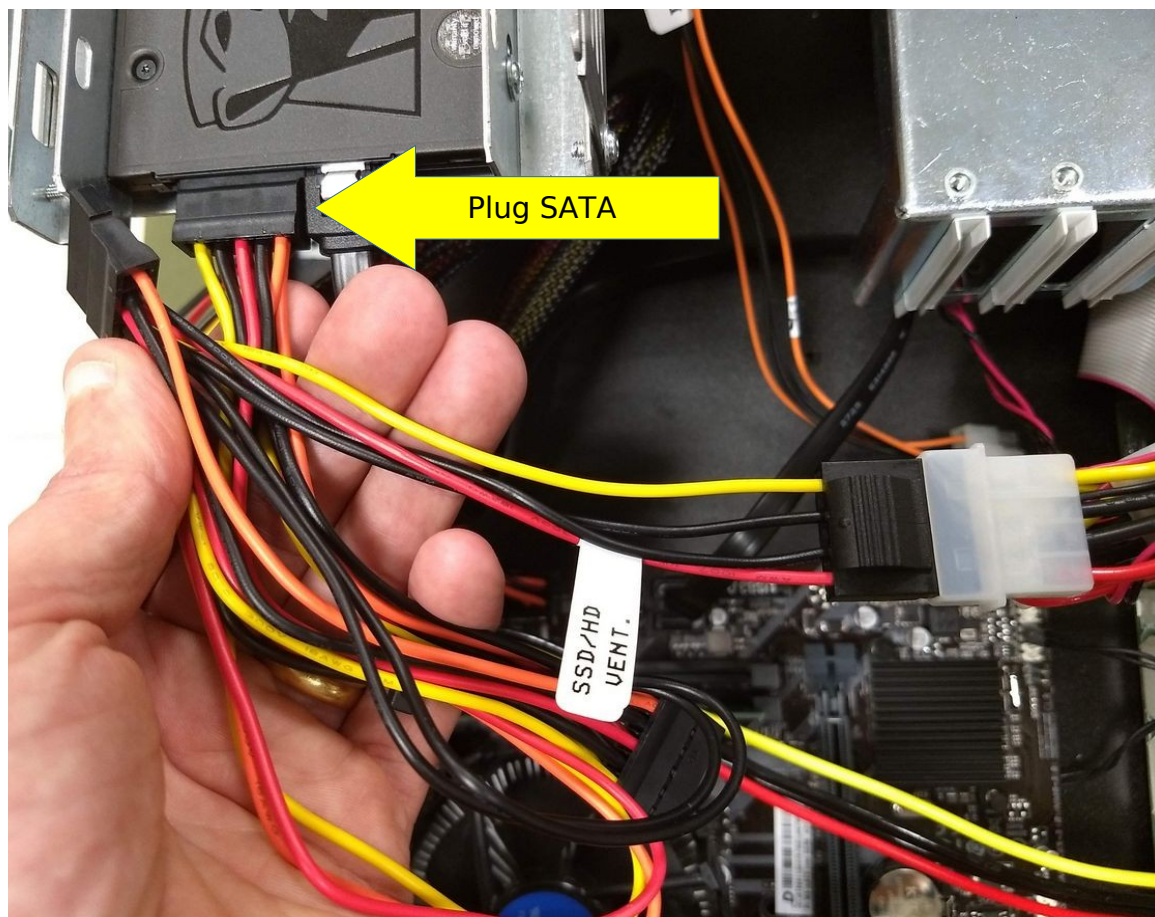

7. Interligar os cabos dos ventiladores frontais e traseiros e ligar no plug final do cabo com etiqueta **SSD/HD VENT.:**

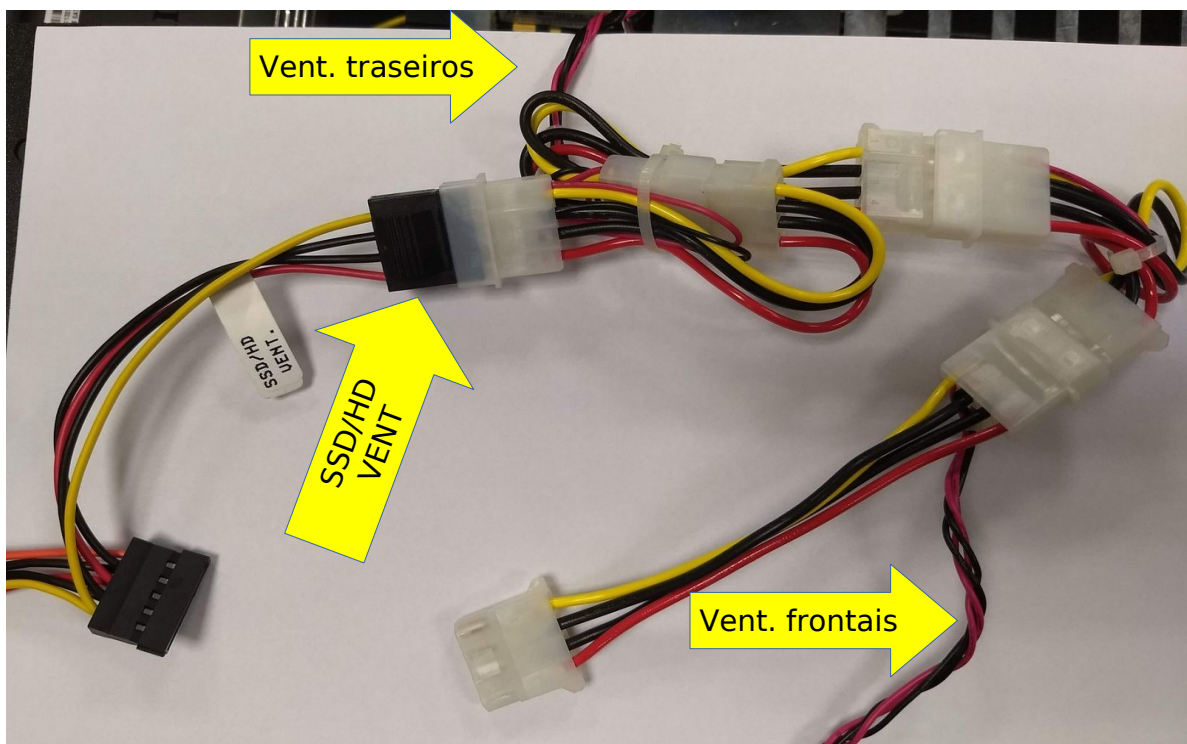

8. Deixar desconectado o cabo com o plug **PCI-E**:



9. Recoloque o cartão DTCV, conecte o cabo de alimentação, os flat cables e o cabo de rede externo DTCV-ETH:

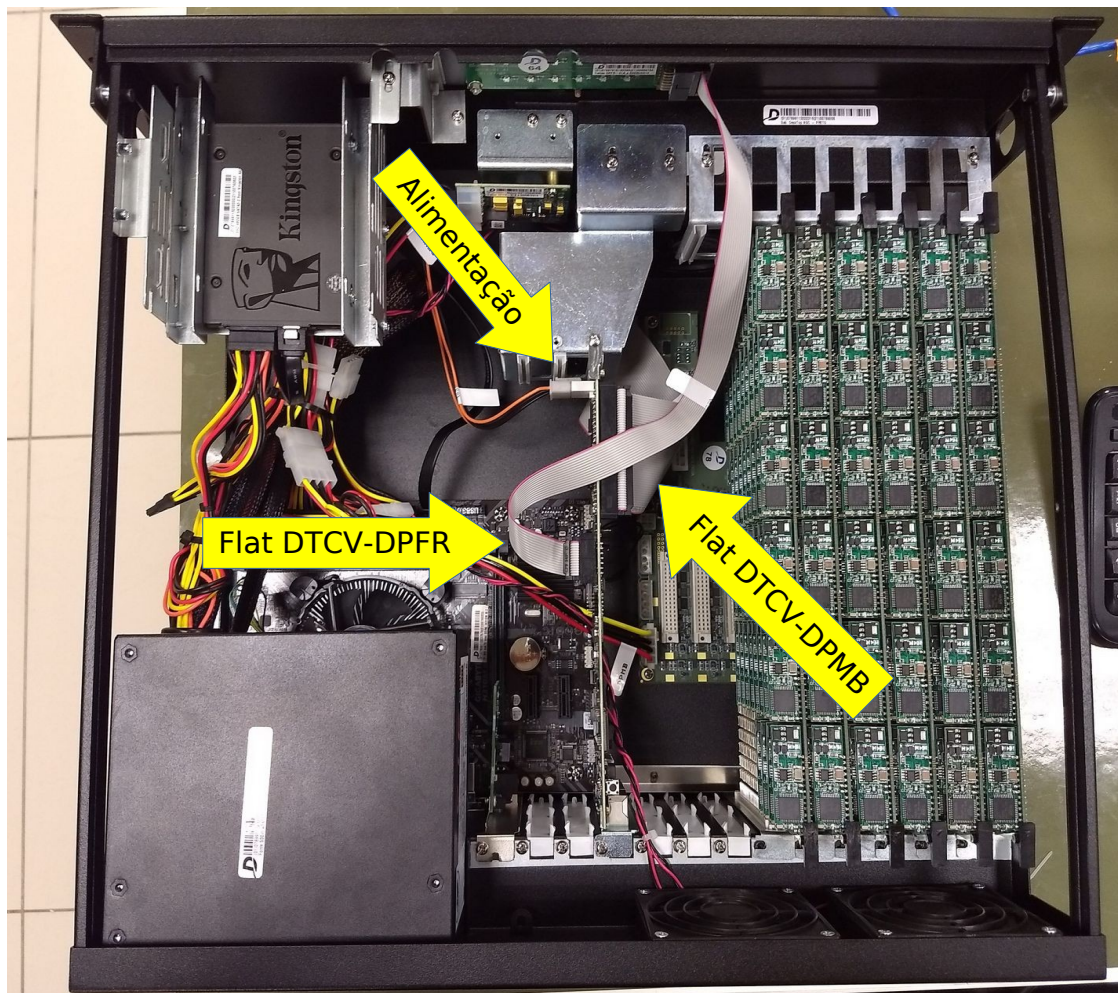

10. Finalize a instalação com abraçadeiras de nylon para acomodar os cabos no interior do gabinete:

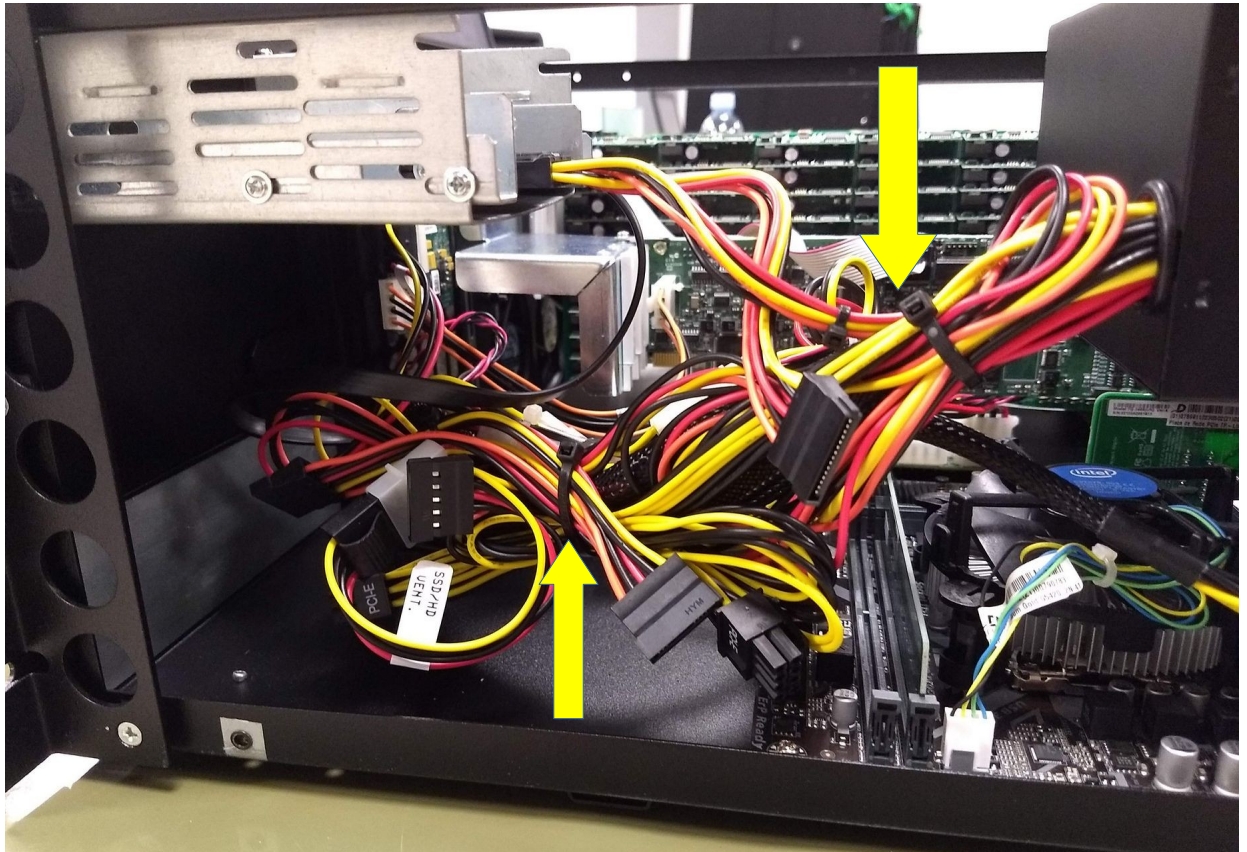

Diagrama de Conexões

